

# Technics®

AV Control Stereo Receiver

SA-EX300

SA-EX100

Operating Instructions

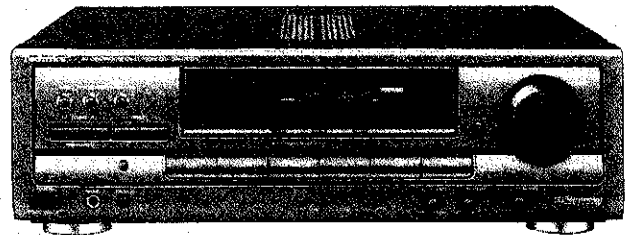

The photographs show SA-EX300.

Before connecting, operating or adjusting this product, please read these instructions completely.

# Accessories

## Dear Customer

Thank you for purchasing this Technics product. For optimum performance and safety, please read these instructions carefully.

These operating instructions are applicable to models SA-EX300 and SA-EX100.

These operating instructions, however, are intended primarily for model SA-EX300.

THIS TUNER/RECEIVER IS CAPABLE OF RECEIVING THE NEW AM STEREO BROADCASTS FROM THE AM BAND RADIO STATIONS. HOWEVER LIKE MANY TUNERS AND RECEIVERS CURRENTLY AVAILABLE ON THE MARKET IT WILL REPRODUCE THIS AM STEREO SIGNAL ONLY IN AM MONO, WHICH, IN EFFECT, IS OF NO LESSER QUALITY THAN YOUR EXISTING AM MONO TUNER/RECEIVER.

## Table of contents

<b>Accessories</b> .....	<b>2</b>
<b>Suggestions for safety</b> .....	<b>3</b>
<b>Front panel controls</b> .....	<b>4</b>
<b>Equipment connections</b> .....	<b>5</b>
<b>Antenna connections</b> .....	<b>8</b>
<b>Speaker connections</b> .....	<b>10</b>
<hr/>	
<b>Basic operations</b> .....	<b>12</b>
To adjust the tone quality .....	13
To adjust the sound balance .....	13
To mute the sound level .....	13
To listen through headphones .....	13
<b>Listening to radio broadcasts</b> .....	<b>14</b>
Sequential tuning .....	14
Preset tuning .....	14
Direct access tuning .....	16
<b>Enjoying sound with DOLBY PRO LOGIC</b>	
<b>SA-EX300 only</b> .....	<b>17</b>
SURROUND .....	17
3 STEREO .....	17
Setting the center mode .....	17
Adjusting speaker output level .....	18
Enjoying with SURROUND or 3 STEREO .....	19
<b>Making a recording</b> .....	<b>20</b>
Recording on the tape deck .....	20
Recording on the VCR (VCR 1) .....	20
<b>Sleep timer function</b> .....	<b>22</b>
<b>About the HELP function</b> <b>SA-EX300 only</b> .....	<b>22</b>
<hr/>	
<b>Troubleshooting guide</b> .....	<b>23</b>
<b>Technical specifications</b> .....	<b>Back cover</b>

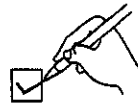

Please check and identify the supplied accessories

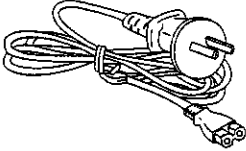
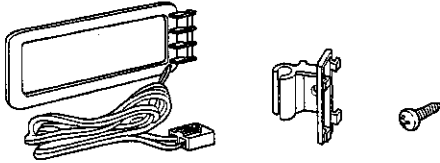
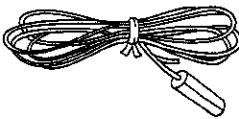
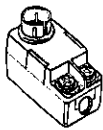
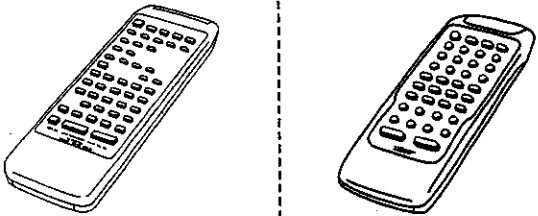
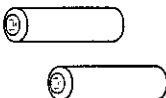
<input type="checkbox"/>	AC power supply cord.....	1 pc.
		
<input type="checkbox"/>	AM loop antenna set	
	• AM loop antenna .....	1 pc.
	• AM loop antenna holder .....	1 pc.
	• Screw .....	1 pc.
		
<input type="checkbox"/>	FM indoor antenna.....	1 pc.
		
<input type="checkbox"/>	Antenna plug.....	1 pc.
		
<input type="checkbox"/>	Remote control transmitter .....	1 pc.
	<b>For SA-EX300</b> (RAK-SA612WH)	
	<b>For SA-EX100</b> (EUR642175)	
		
<input type="checkbox"/>	Batteries (UM-4, "AAA", R03) .....	2 pcs.
		

For details on remote control transmitter operation, refer to "How to use the remote control transmitter" in the separate booklet.

# Suggestions for safety

## Placement

Avoid placing the unit in areas of:

- direct sunlight
- high temperature
- high humidity
- excessive vibration
- uneven surfaces (Place the unit on a flat level surface.)

Such conditions might damage the cabinet and/or other component parts and thereby shorten the unit's service life.

## Ventilation

- Place the unit in a well ventilated position at least 10 cms away from wall surfaces etc.
- Ensure that curtains and similar materials do not obstruct the ventilation holes.

## Stacking

Never place heavy items on top of the unit or the power cord.

## Voltage

- It is very dangerous to use an AC power source of high voltage such as for an air conditioner.  
A fire might be caused by such a connection.
- A DC power source can not be used.  
Be sure to check the power source carefully, especially on a ship or other place where DC is used.

## Power cord protection

- Avoid cuts, scratches or poor connection of the AC mains cord, as this may result in fire or electric shock hazard.  
Excessive bending, pulling or slicing of the cord should also be avoided.
- Do not pull on the cord when you are disconnecting the power, as this could cause an electric shock. Grasp the plug firmly when you disconnect the power supply.
- Never touch the plug with wet hands or a serious electric shock could result.

## Foreign materials

- Ensure that no foreign objects, such as needles, coins, screw-drivers etc., accidentally fall into the unit or through the ventilation holes.  
Otherwise, a serious electric shock or malfunction could occur.
- Be extremely careful about spilling water or liquid on/into the unit, as a fire or electric shock could occur.  
(Disconnect the power plug and contact your dealer immediately if this occurs.)
- Avoid spraying insecticides onto the unit as they contain flammable gases which can be ignited.
- Insecticides, alcohol, paint thinner and similar chemicals should never be used to clean the unit as they can cause flaking or cloudiness to the cabinet finish.

## Maintenance

Clean the cabinet, panel and controls with a soft cloth lightly moistened with mild detergent solution.

Do not use any type of abrasive pad, scouring powder or solvent such as alcohol or benzine.

## Service

- Never attempt to repair, disassemble or reconstruct the unit if there seems to be a problem.  
A serious electric shock could result if you ignore this precautionary measure.
- If a problem occurs during operation (the sound is interrupted, indicators fail to illuminate, smoke is detected, etc) contact your dealer or Authorized Service Center immediately.
- Disconnect the power supply if the unit will not be used for a long time. Otherwise the operation life could be shortened.

### CAUTION

Do not place a tape deck or CD player on top of this unit. Heat radiated from the top of this unit may cause damage to the tape or CD software.

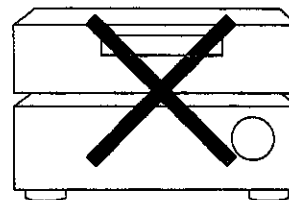

**NO**

### CAUTION!

DO NOT INSTALL OR PLACE THIS UNIT IN A BOOKCASE, BUILT IN CABINET OR IN ANOTHER CONFINED SPACE IN ORDER TO KEEP WELL VENTILATED CONDITION. ENSURE THAT CURTAINS AND ANY OTHER MATERIALS DO NOT OBSTRUCT THE VENTILATION CONDITION TO PREVENT RISK OF ELECTRIC SHOCK OR FIRE HAZARD DUE TO OVERHEATING.

# Front panel controls

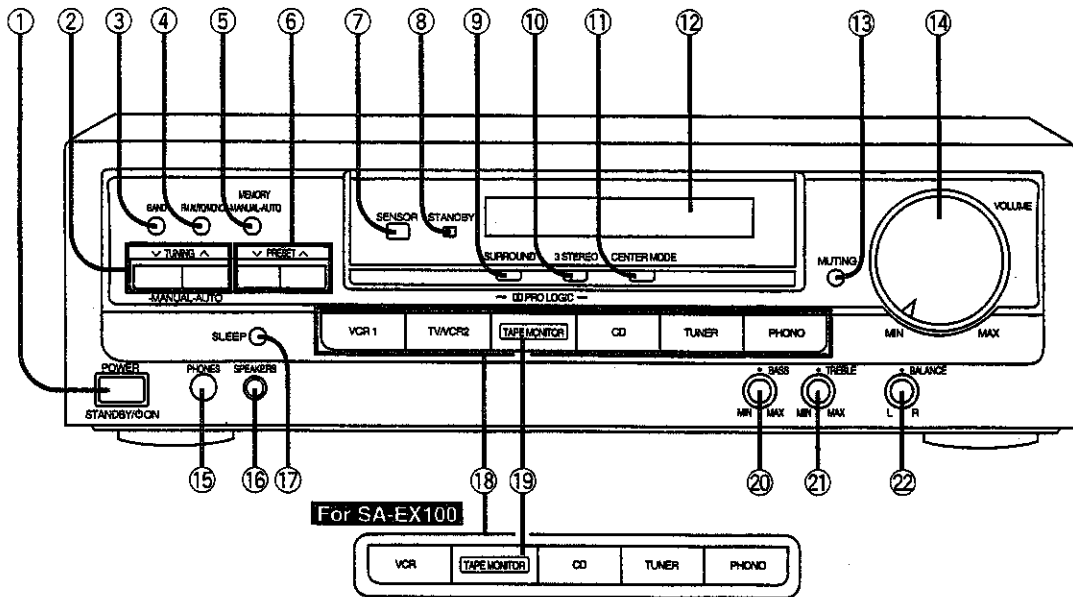

No.	Name	Ref. page
①	Power "STANDBY  /ON" switch (POWER, STANDBY  /ON) Press to switch the unit from on to standby mode or vice versa. In standby mode, the unit is still consuming a small amount of power.	12
②	Tuning buttons (TUNING)	14
③	Band select button (BAND)	14
④	FM mode select button (FM AUTO/MONO)	14
⑤	Memory button (MEMORY)	15
⑥	Preset channel buttons (PRESET)	15,16
⑦	Remote control signal sensor (SENSOR)	-
⑧	"STANDBY" Indicator (STANDBY) When the unit is connected to the AC mains supply, this indicator lights up in standby mode and goes out when the unit is turned on.	-
⑨	<b>SA-EX300 only</b> Surround button (SURROUND)	17,18,19
⑩	<b>SA-EX300 only</b> 3 stereo button (3 STEREO)	17,18,19

No.	Name	Ref. page
⑪	<b>SA-EX300 only</b> Center mode select button (CENTER MODE)	17
⑫	Display	-
⑬	Muting button (MUTING)	13
⑭	Volume control (VOLUME)	12
⑮	Headphones jack (PHONES)	13
⑯	Speaker button (SPEAKERS)	12
⑰	<b>SA-EX300 only</b> Sleep timer button (SLEEP)	22
⑱	Input select buttons	12
⑲	Tape monitor button (TAPE MONITOR)	12,20
⑳	Bass control (BASS)	13
㉑	Treble control (TREBLE)	13
㉒	Balance control (BALANCE)	13

# Equipment connections

Make sure that the power supply for all components has been turned off before making any connections.

**Stereo connection cable**  
(not included)



**Note**

Do not place books, etc., on top of this unit or block the heat radiation vents in any way

## SA-EX300

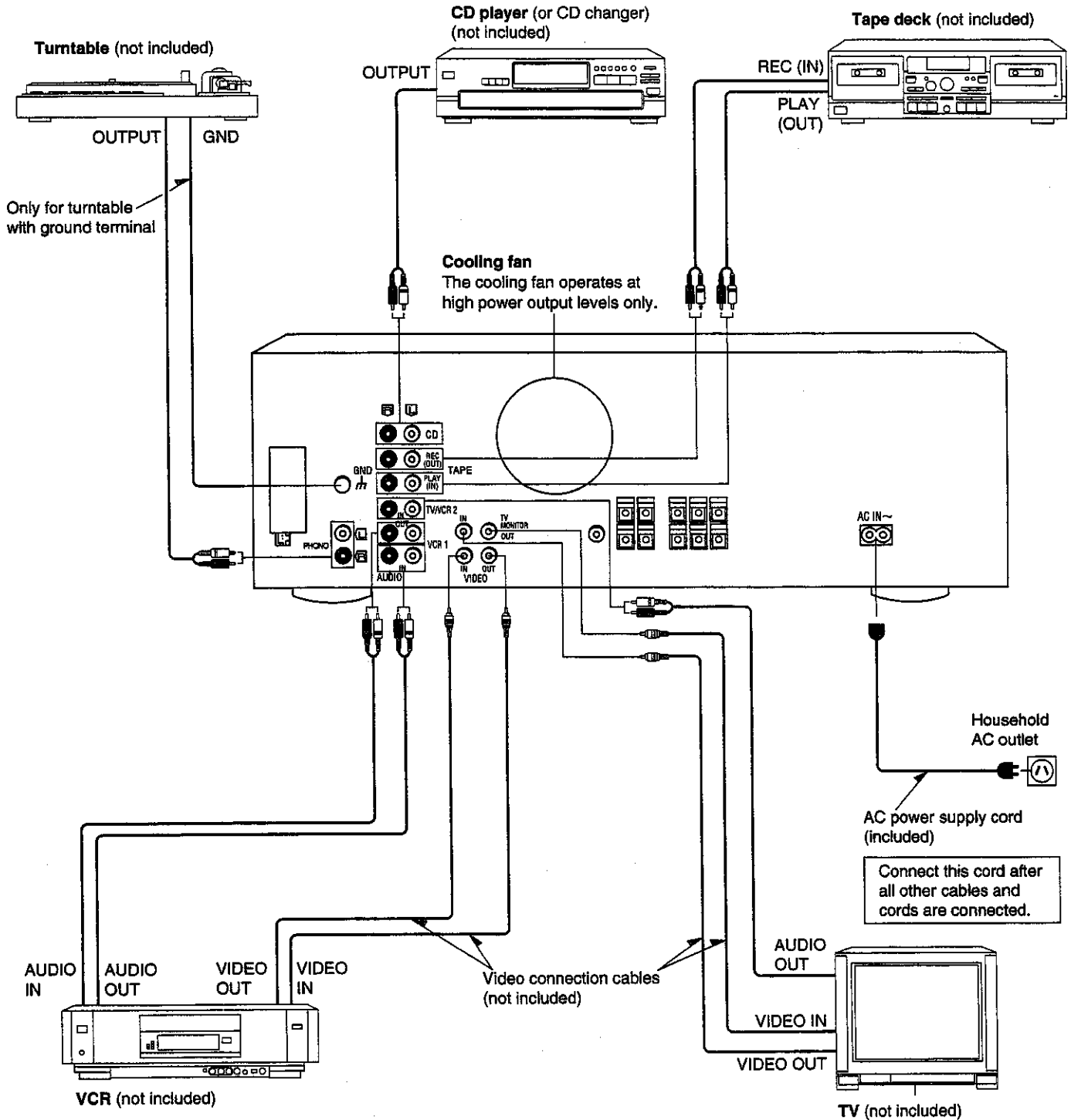

# Equipment connections

Make sure that the power supply for all components has been turned off before making any connections.

**Stereo connection cable** (not included)  (L) White  
(R) Red

**Note**  
Do not place books, etc., on top of this unit or block the heat radiation vents in any way

## SA-EX100

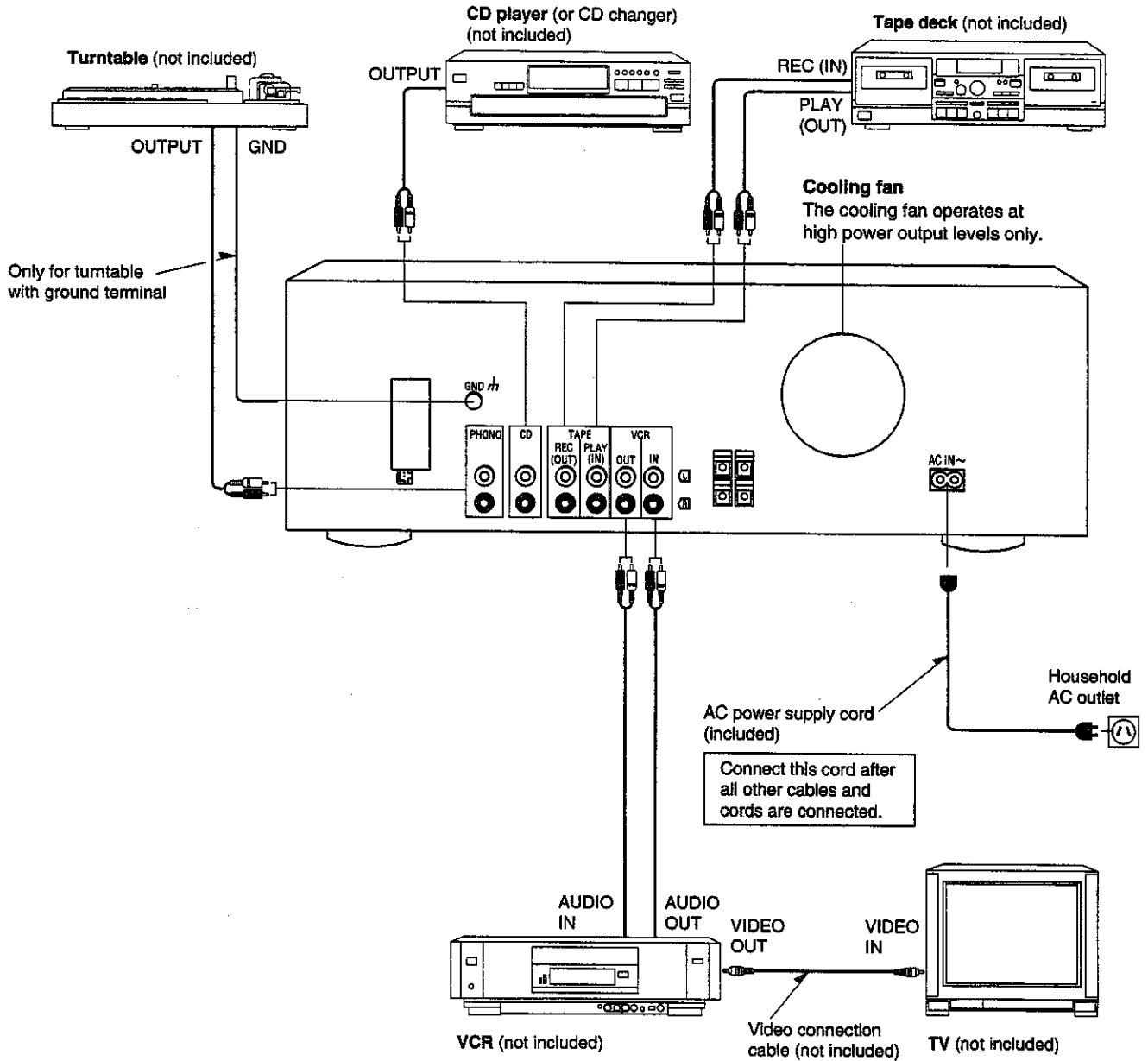

**To connect a TV and VCR with 21 pin scart terminal SA-EX300 only**

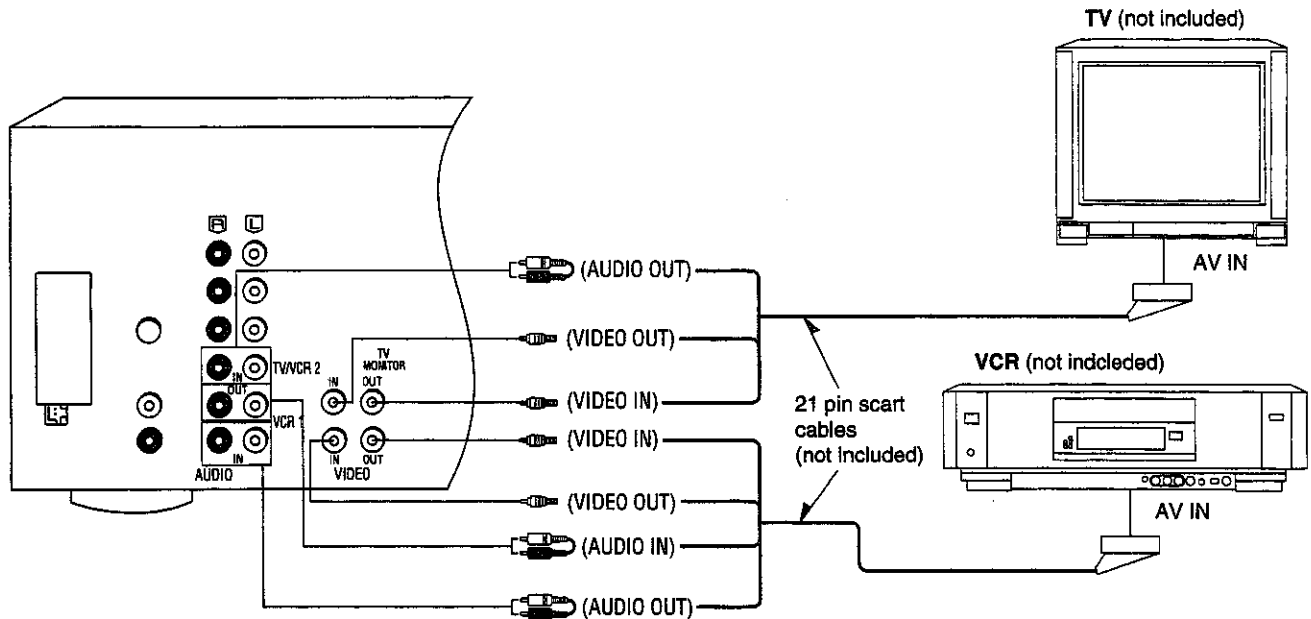

**To connect a second VCR SA-EX300 only**

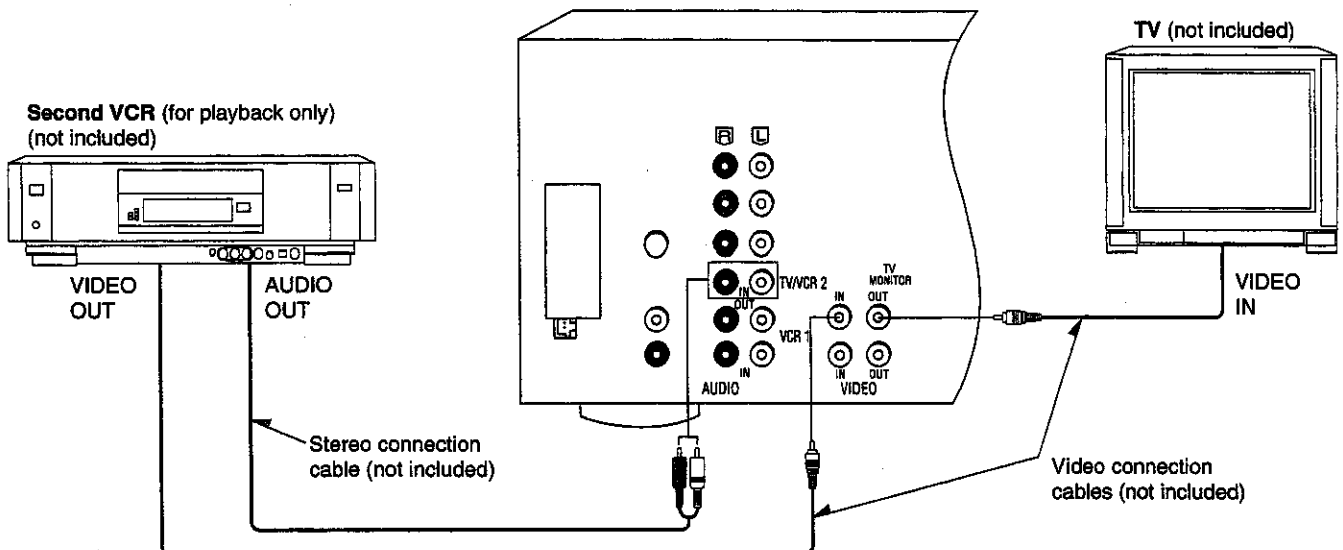

# Antenna connections

## FM indoor antenna (included)

This antenna is normally sufficient for reception of FM broadcasts.

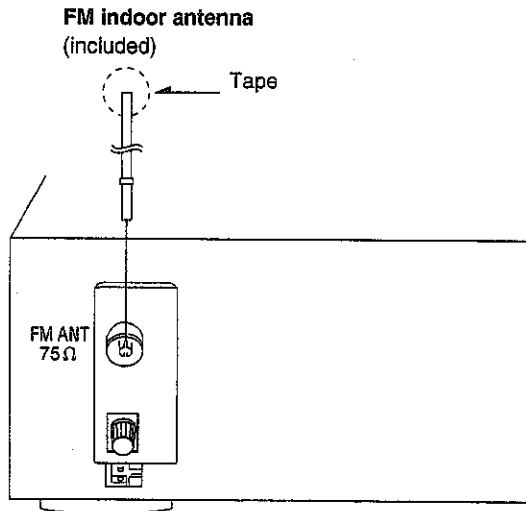

Attach to a wall (using a tack or tape) facing in the direction of best reception.

### For best reception sound quality

An FM outdoor antenna is recommended.  
Disconnect the antenna if an FM outdoor antenna is installed.

## FM outdoor antenna (not included)

The outdoor antenna should be used when using the main unit in mountainous areas or in spaces enclosed by reinforced concrete where the FM indoor antenna (included) does not provide satisfactory reception.

### Note

An outdoor antenna should be installed by a qualified technician only.

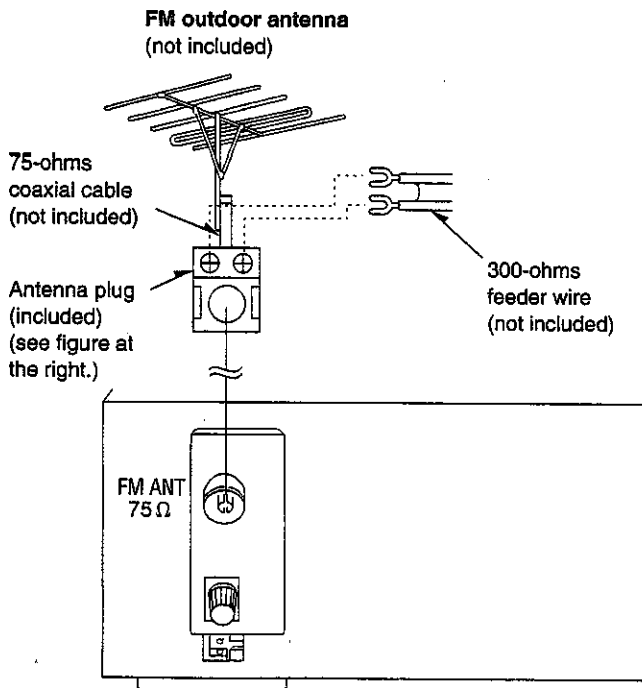

## How to use the antenna plug (included)

Two types of wire are most commonly used for connection from the antenna: 300-ohms parallel feeder wire or 75-ohms coaxial cable. For best resistance to outside interference, the use of 75-ohms coaxial cable is suggested.

### To connect a 75-ohms coaxial cable

- 1 Remove a piece of the outer vinyl insulator.



- 2 Remove the cover while pulling the tabs.

### Note

If the tabs are pulled too hard, the casing may be damaged.

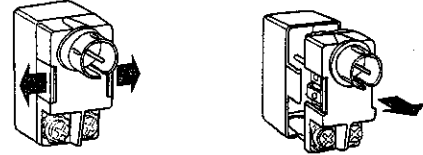

- 3 Remove the lead wire and clamp it with the plastic bar.

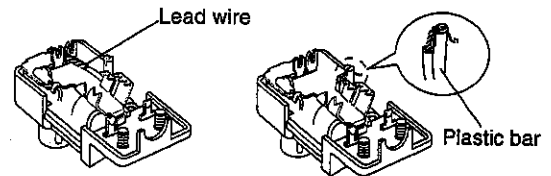

- 4 Install the coaxial cable.

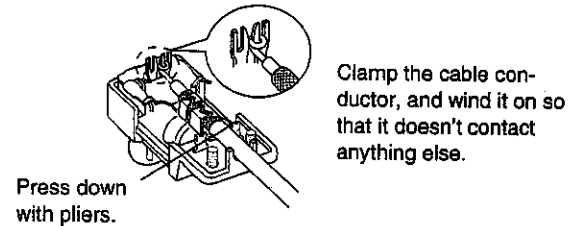

- 5 Attach the cover.

### To connect a 300-ohms feeder wire

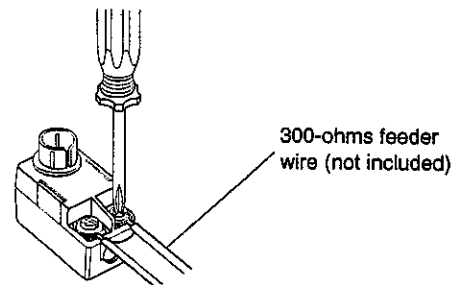

Loosen the screw to connect the feeder wire and tighten it to secure the connection.



## AM loop antenna (included)

This antenna is normally sufficient for reception of AM broadcasts.

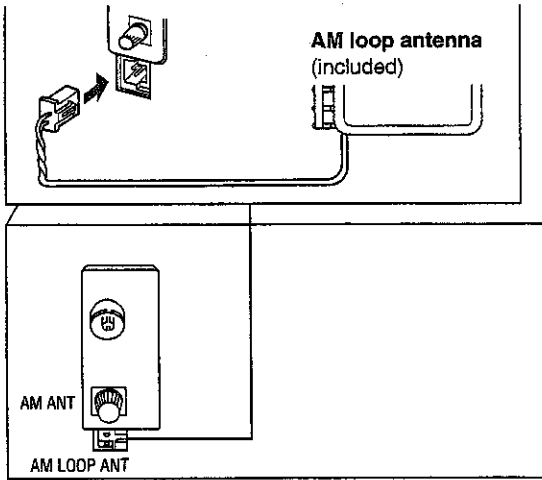

Install the AM loop antenna holder (included) at the rear panel of this unit and then attach the AM loop antenna to the AM loop antenna holder (facing in the direction of best reception).

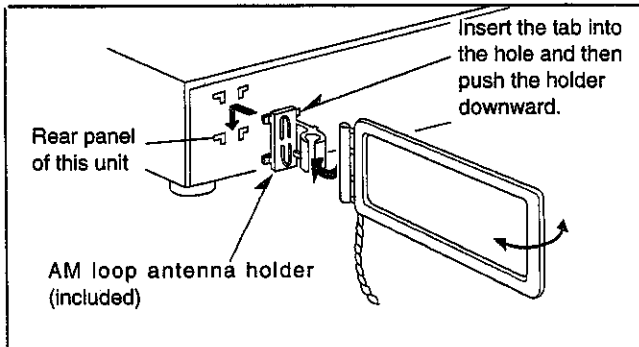

### When mounting the antenna to a column, a wall or rack

Mount it vertically.

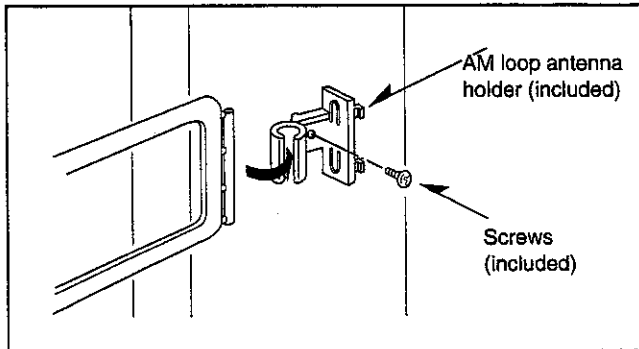

Pay attention to the following points when mounting the antenna.

- Do not mount it horizontally (doing so will impair reception).
- Do not mount it close to power supply cords, speaker wires or metal surfaces (doing so will result in noise).
- Do not mount it close to a tape deck. When the tape deck is being used, chirping or beeping sounds may result.

## AM outdoor antenna (not included)

The outdoor antenna should be used when using the main unit in mountainous areas or in spaces enclosed by reinforced concrete where the AM loop antenna (included) does not provide satisfactory reception.

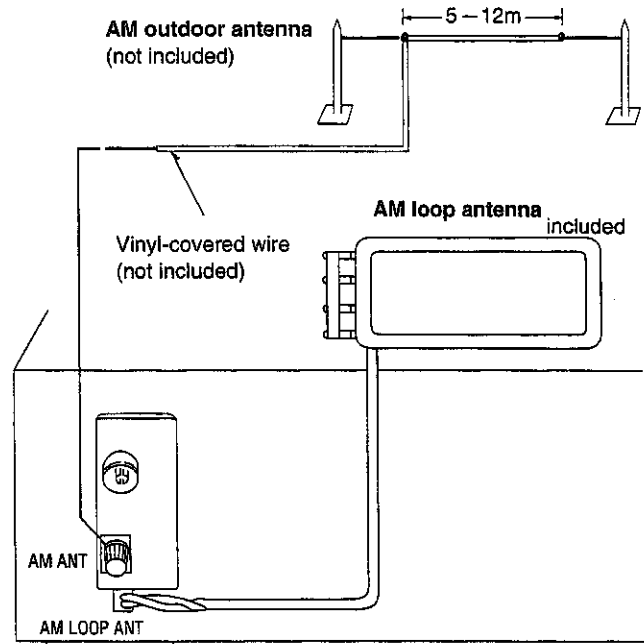

Stretch 5-12 m of vinyl-covered wire horizontally across a window frame or other convenient location, keeping it as high as possible from the ground.

When the unit is not in use, disconnect the outdoor antenna to prevent possible damage that may be caused by lightning. Never use an outdoor antenna during an electrical storm.

### Note

Be sure to connect the AM loop antenna even when an AM outdoor antenna is used.

# Speaker connections

## Speaker layout for Dolby Pro Logic Systems **SA-EX300 only**

As well as enjoying normal stereo reproduction with the left and right front speakers, a center speaker and surround speakers can also be connected to this unit in order to enjoy the sound performance of Dolby Pro Logic Systems.

The illustration below shows where to place the speakers so as to best enjoy sound with Dolby Pro Logic systems.

We recommend that surround speakers be placed on the side of or slightly behind the listener, and about one meter higher than ear level.

However the position should be adjusted to your personal preference, because the effect varies to some degree depending upon the sources.

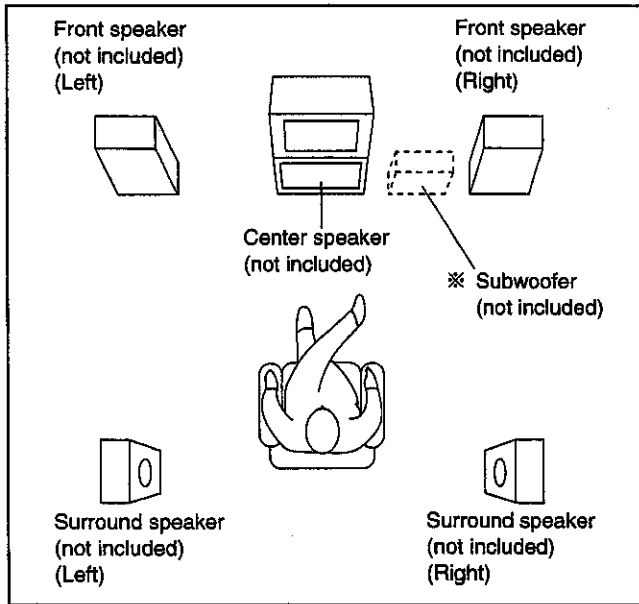

※ The subwoofer can be placed in any position.

## Connection of front speakers

For SA-EX300

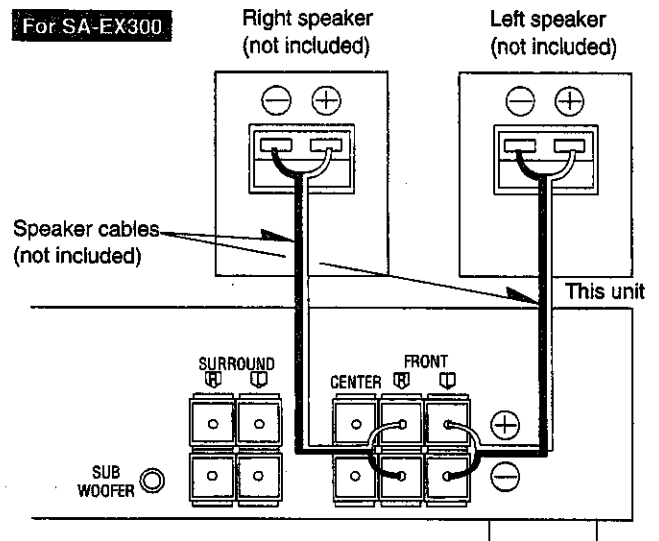

For SA-EX100

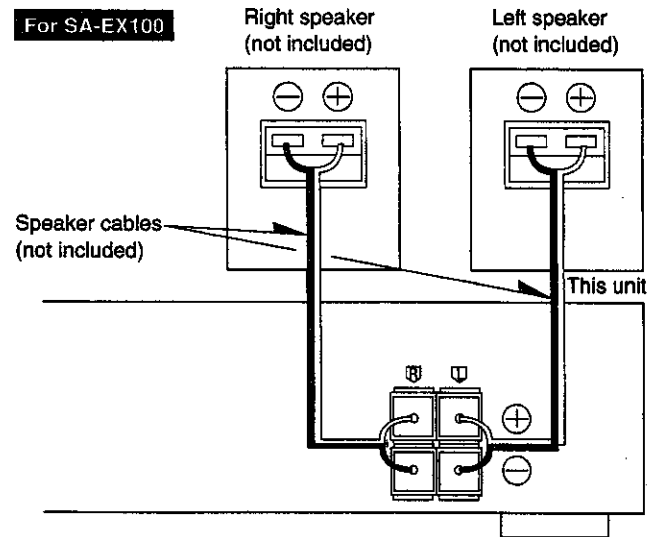

### Connecting the speaker cords

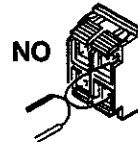
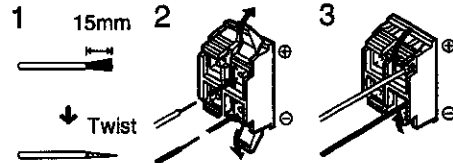

#### Note

To prevent damage to circuitry, never short-circuit positive (+) and negative (-) speaker wires.

### Speaker Impedance

The impedance of any speaker used with this unit must be 8-16 Ω.

## Connection of surround speakers

SA-EX300 only

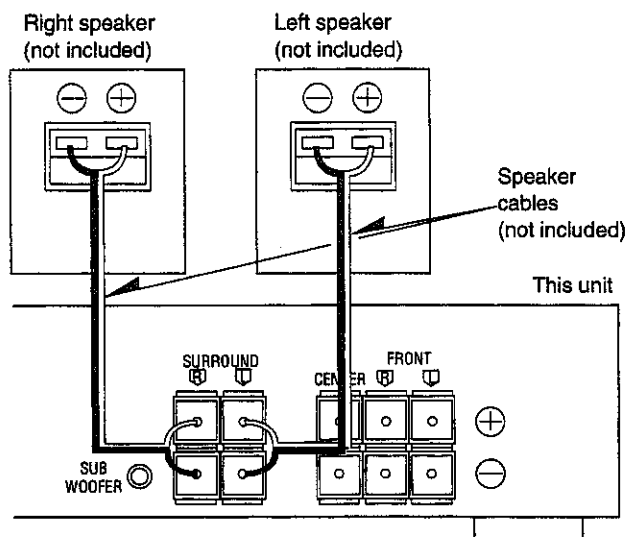

### Note

1. Before sound can be heard, both surround speakers must be connected.
2. Do not connect the surround speakers to the front speaker terminals. The surround speakers may be damaged if connected to the front terminals due to the output power difference between the front and surround terminals.

### Speaker impedance

The impedance of any speaker used with this unit must be 4-16  $\Omega$ .

## Connection of center speaker

SA-EX300 only

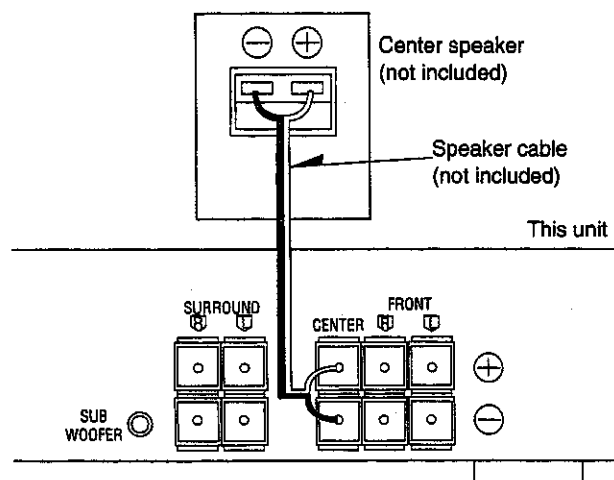

### Note

Before sound can be heard, the SURROUND mode or 3 STEREO mode (of the Dolby Pro Logic system) must be on.

### Speaker impedance

The impedance of any speaker used with this unit must be 8-16  $\Omega$ .

## Connection of subwoofer

SA-EX300 only

You can amplify bass sounds by connecting a subwoofer to your receiver.

When connected, the subwoofer can be placed in any position.

### Note

This receiver has no amplifier section designed especially for the subwoofer, so you cannot adjust the subwoofer volume level by the receiver.

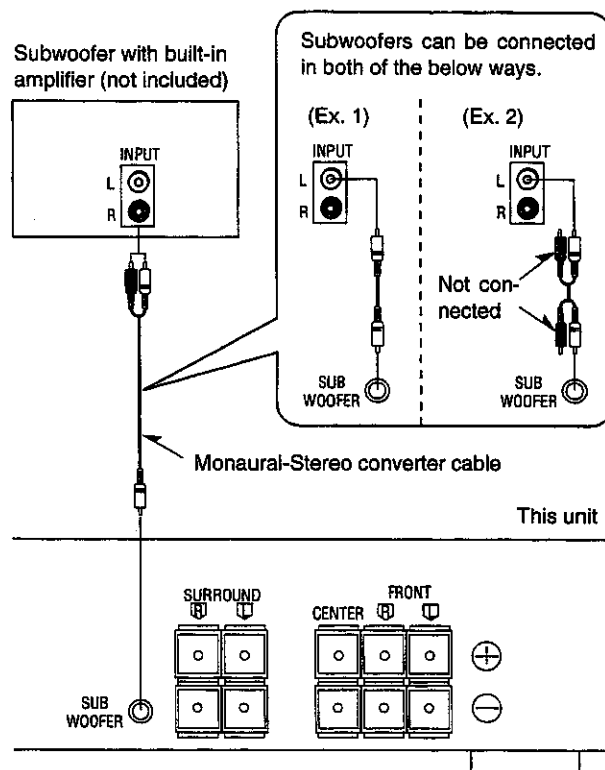

## Connecting a subwoofer which does not have a built-in amplifier

Connect an optional amplifier to the "SUBWOOFER" terminals of this unit and then connect a subwoofer to the speaker terminals of the amplifier.

# Basic operations

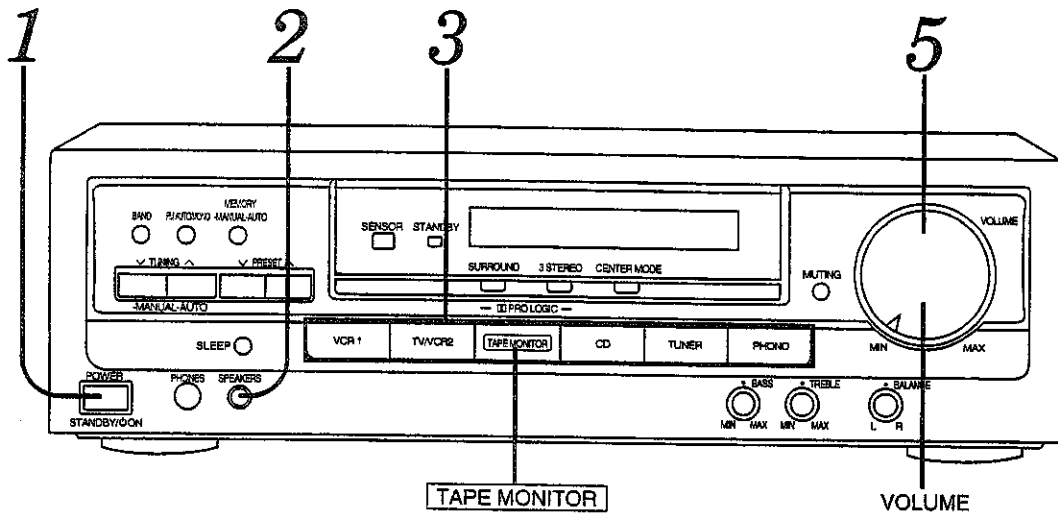

Before operation, set VOLUME to the "MIN" position.

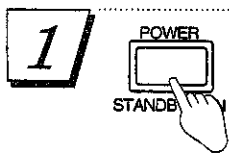

**1** Press **POWER** to switch on the power.

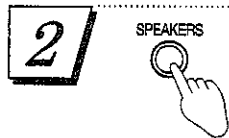

**2** Press **SPEAKERS** and check the "SPEAKERS" indication lights up.

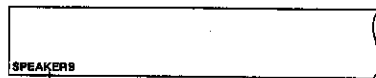

Lights up

If the button is pressed once more, the indicator will switch off and no sound will be heard from the speakers.

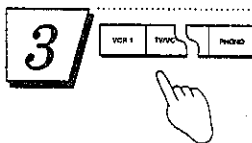

**3** Press to select the desired source.

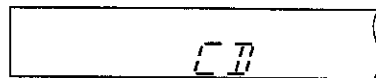

Example shows CD is selected as the source.

**For SA-EX300**

- VCR 1:** To watch video tapes (VCR 1)
- TV/VCR 2:** To watch TV or video tapes (VCR 2)
- TAPE MONITOR:** To listen to cassette tapes (The tape monitor indicator will appear.) (See right.)
- CD:** To listen to compact discs
- TUNER:** To listen to radio broadcasts
- PHONO:** To listen to phono discs

**Note**

To watch a video or the TV, set the TV to either the TV mode or VIDEO mode as indicated below.

- To enjoy videos (VCR 1 or VCR 2)  
Set it to VIDEO mode.
- To watch TV  
Set it to TV mode.

**For SA-EX100**

- VCR:** To listen to video tapes
- TAPE MONITOR:** To listen to cassette tapes (The tape monitor indicator will appear.) (See below.)
- CD:** To listen to compact discs
- TUNER:** To listen to radio broadcasts
- PHONO:** To listen to phono discs



**4** Start the desired source.  
(Refer to the appropriate operating instructions for details.)



**5** Turn **VOLUME** to adjust the volume level.

**After listening is finished**

Be sure to reduce the volume level, and switch the power to the standby condition by pressing POWER.

**When the tape monitor indicator is lit or flashing**

This indicates that the tape monitor function of this unit is ON. To listen to sources other than a tape, be sure to press **TAPE MONITOR** and check the indicator goes out.

Lit or flashing

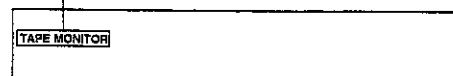

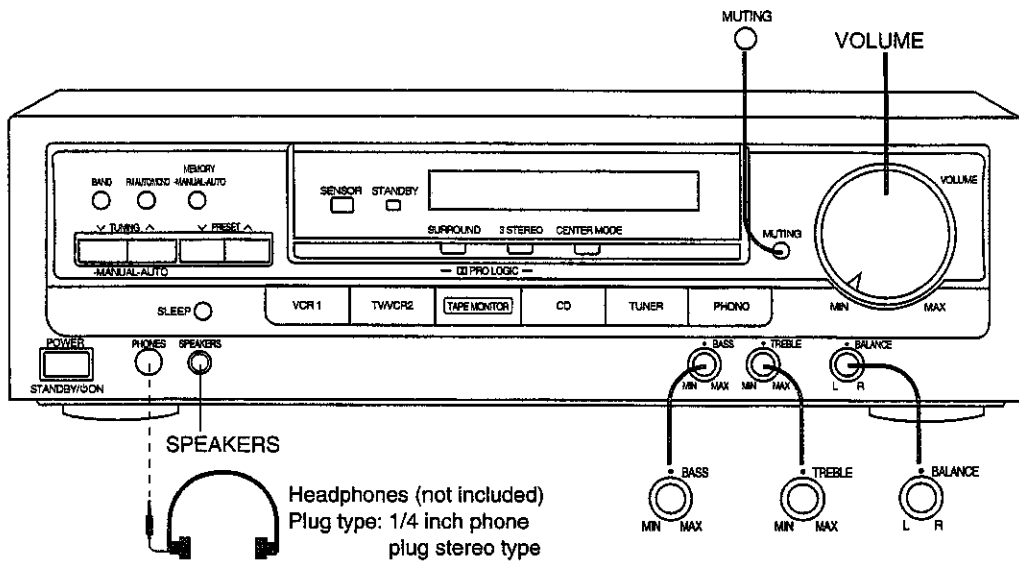

### To adjust the tone quality



Turn **BASS** to adjust the low frequency sound.



Turn **TREBLE** to adjust the high frequency sound.

### To mute the sound level



Press **MUTING**.



The message "MUTING ON NOW" runs repeatedly from right to left across the display as long as the muting function is on.

Press once again to return to the previous volume level.

### To adjust the sound balance

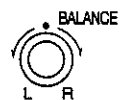

Turn **BALANCE** to adjust the left/right sound balance.

### To listen through headphones

Use **VOLUME** to reduce the volume level, and connect the headphones.

If you do not want sound from the speakers, press **SPEAKERS** and check the "SPEAKERS" indication goes out.

#### SA-EX300 only

If a subwoofer is connected to your system, turn off power to it or the subwoofer amp you are using.

#### Note

Avoid listening for prolonged periods of time to prevent hearing damage.

# Listening to radio broadcasts

## Sequential tuning

You can use the tuning buttons to tune-in radio broadcasts.

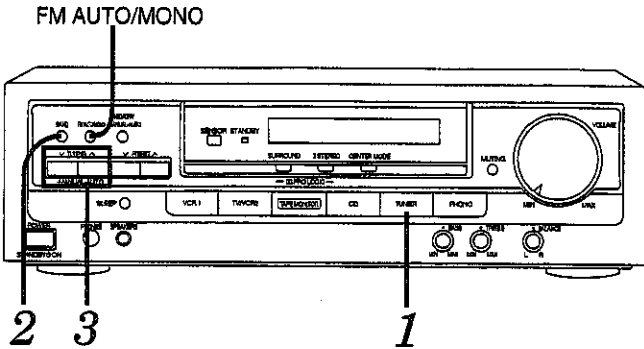

**1** Press **TUNER**.

**2** Press **BAND** to select "FM" or "AM".

Selected band: **FM**

**3** Press **∇** or **∧** to tune to the desired broadcast.

If either button is held down for an instant until the frequency begins to scroll, the broadcast stations can be tuned in automatically when a broadcast station is found.

**Note**  
Tuning may stop automatically if any jamming is encountered.

Lights up when tuned

Lights up when an FM stereo broadcast is received

QUARTZ LOCK STEREO

FM 88.10 MHz

Frequency display

**If noise is excessive in the FM stereo mode**  
Press FM AUTO/MONO. (The "STEREO" indication will switch off.)

QUARTZ LOCK MONO

FM 88.10 MHz

Lights up

The broadcast will be monaural, but noise will be reduced. If the button is pressed once more, the stereo mode will be resumed.

## Preset tuning

Presetting radio stations into the memory channels of this unit makes selecting stations easy and simple.

### Before presetting

**How many broadcast stations can be preset?**  
A total of 30 FM and AM stations can be preset.

### How is presetting done?

The two following methods are available.

#### ① Automatic memory presetting

Automatic memory presetting allows this unit to automatically search for broadcast stations and then preset them into memory.

With this function, searching proceeds from the frequency currently being displayed and continues through higher frequencies, and broadcast stations are preset in the order in which they are located.

With this method, the channels that can be preset into the memory are set as follows for different bands (FM or AM).

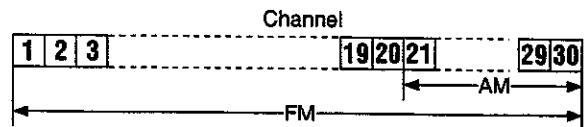

For FM broadcast stations.....1-30  
For AM broadcast stations.....21-30

#### If the FM stations (channels 1-30) are preset and then the AM stations (channels 21-30) are preset

Because this unit can accommodate a total of 30 preset channels, the settings for FM channels 21-30 will be replaced by the AM settings which were subsequently preset, and the channel allotment will be as shown below.

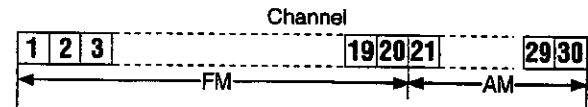

For FM broadcast stations.....1-20  
For AM broadcast stations.....21-30

#### ② Manual memory presetting

The desired broadcast stations can be preset into the desired channels by the user.

This can also be used as a method for changing selected broadcast stations that were preset in "Automatic memory presetting".

### Please remember this

If a new broadcast station is preset into a channel, the setting for the broadcast station which was previously entered in that channel will be automatically erased.

## Automatic memory presetting

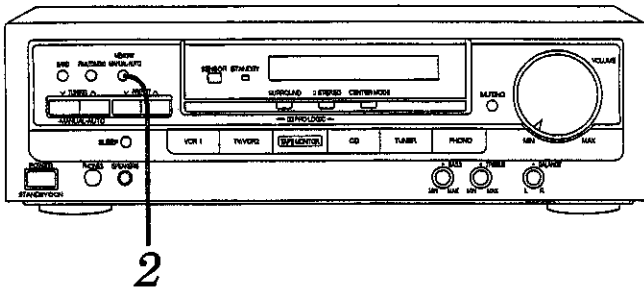

**1** Set to the frequency from which you want to start automatic memory presetting. (See page 14.)

**2** Press MEMORY until the frequency begins to change. (Automatic memory presetting will start.)

During automatic memory presetting, the memory indicator will flash while the frequency scrolls.

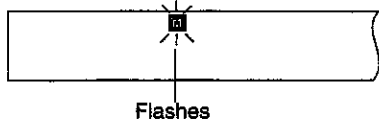

To stop, press MEMORY once again.

### When a broadcast station is preset

The memory indicator and the preset channel number will be displayed for approximately 1 second.

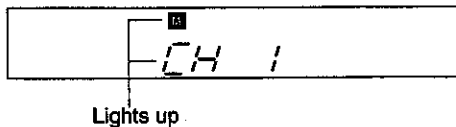

### When presetting is completed

The last broadcast station to be preset will be displayed.

#### Note

Frequencies may not be preset correctly in cases where the broadcast waves are too strong or too weak. In such cases, carry out presetting manually.

## Manual memory presetting

FM AUTO/MONO

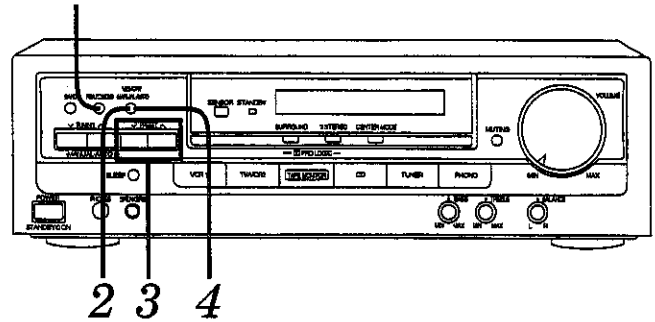

**1** Set to the desired broadcast. (See page 14.)  
If interference or static is keeping you from enjoying an FM broadcast, press FM AUTO/MONO and change to monaural. You can preset the memory in monaural just as in stereo.

**2** Press MEMORY. (Touch only.)

Lights up

To cancel the memory function, press MEMORY again.

**3** Press  $\nabla$  or  $\wedge$  to select the desired channel.

Flashes

Holding the buttons down lets you scroll through channels faster.

**4** Press MEMORY.

The channel will blink on the display.

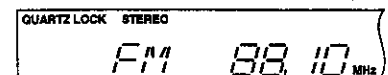

### To continue presetting

Repeat steps 1 through 4.

# Listening to radio broadcasts

## Preset tuning (continued)

### To listen to preset broadcast stations

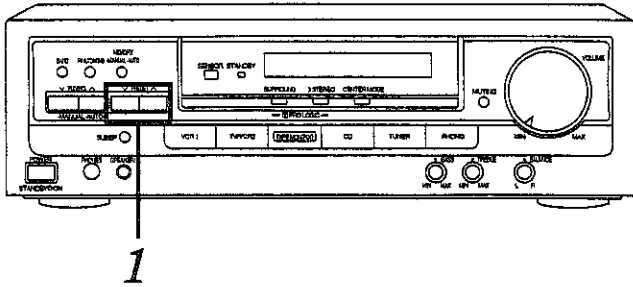

**1** Press  $\nabla$  or  $\wedge$  to select the desired channel.

Preset channel

Holding the buttons down lets you scroll through channels faster.

After the preset channel is displayed, the frequency of the selected channel is displayed.

You can select channels from the remote control with the numeric buttons. See the instruction manual on "How to use the remote control transmitter".

### To confirm the channel number of the broadcast station being received

Press TUNER.  
(The channel number will be displayed for approximately 1 second.)

**Note**

The channel number is not displayed if you change the reception frequency or FM mode setting.

### For your reference

Even if the power is switched to standby or the power cord is disconnected from the household AC outlet, the memory will retain its contents for approximately one month.

### If frequency presettings are accidentally erased

Make the presettings once again.  
The power cord should remain connected for one hour or more for the memory back-up to be effective.

## Direct access tuning

(Only available from the remote control.)

Specify the frequency using the numeric buttons on the remote control transmitter to directly tune to the desired broadcast station.

**Note**

First select the band with the BAND button on the receiver.

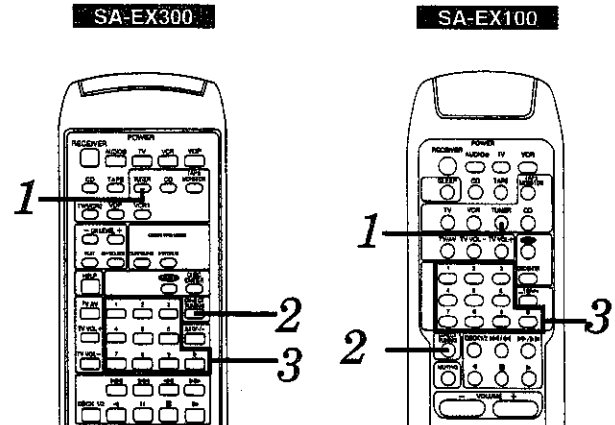

**1** Press TUNER.

This will set the remote control to operate the tuner.

**2** Press DIRECT TUNING.

Flashes

While cursor display is flashing (approx. 10 seconds)

**3** Press the appropriate numeric buttons to enter the frequency.

If the desired FM frequency is 107.90 MHz

1 → 0 → 7 → 9 → 0



If the frequency has been input correctly, the displayed frequency will blink once.

**Notes**

- If no button is pressed while the cursor display is flashing, the display will return to the frequency which is currently being received. To re-specify the frequency, repeat the procedure from step 2.
- If the frequency has not been input correctly, "ERROR" indication will be displayed. In this case, re-enter the frequency.



# Enjoying sound with DOLBY PRO LOGIC SA-EX300 only

By combining front, center and surround speakers, you can enjoy the SURROUND mode which conveys a feeling of presence or the 3 STEREO mode which conveys a feeling of orientation.

## SURROUND

By reproducing the feeling of depth and movement of sound, video software or compact discs recorded with Dolby Surround provide the listener with a feeling of presence like that of a movie theater.

To enjoy SURROUND, be sure to connect the surround speakers.

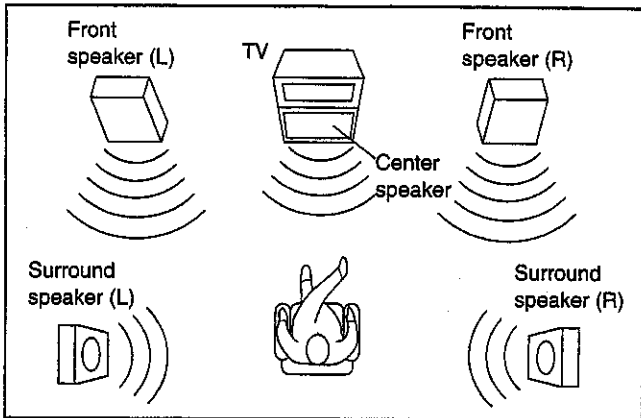

## 3 STEREO

You can enjoy audio/video sources with clear sound, more presence and a good feeling of orientation. 3 STEREO can be used with non DOLBY SURROUND recordings.

To enjoy 3 STEREO, be sure to connect the center speaker.

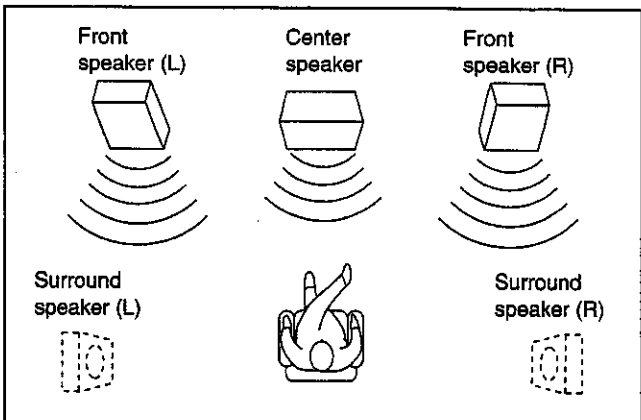

Manufactured under license from Dolby Laboratories Licensing Corporation.

"Dolby", the double-D symbol  and "Pro Logic" are trademarks of Dolby Laboratories Licensing Corporation.

## Setting the center mode

For Dolby Pro Logic systems, center mode setting is necessary to play back bass sounds effectively.

Set the center mode in accordance with the size of your center speaker.

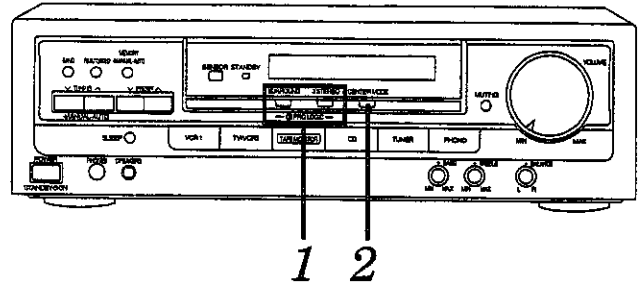

**1**

SURROUND

**Press SURROUND or 3 STEREO to turn on the desired mode.**

Pressing the same button again turns off the activated listening mode.

or



3 STEREO

**For SURROUND mode**



Displayed for approximately 1 second only.

**For 3 STEREO mode**



Displayed for approximately 1 second only.

**2**

CENTER MODE

**Press CENTER MODE to select the correct center mode.**

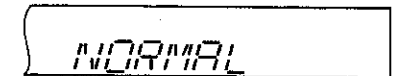

When the button is pressed, the current center mode is displayed.

Pressing it again changes the center mode.

### NORMAL

When the center speaker is smaller than the front speakers

### WIDEBAND

When the center speaker is the same or larger size as the front speakers

### PHANTOM **SURROUND only**

When no center speaker is connected.

### Note

In the PHANTOM mode, the sound which would have been sent to the center speaker will be divided equally between both the left and right front speakers.

## Adjusting speaker output level (Only available from the remote control.)

In order to reproduce the movement of the sound and its clear orientation, it is important to adjust the output level of each speaker. Adjust output to the correct levels while listening to the test signal.

**Note**

- When ready to adjust speaker output level, situate yourself away from the speakers as you normally do when listening.
- First turn ON the speakers with the SPEAKERS button on the receiver.
- If front speakers volume is unbalanced, adjust the balance with the BALANCE knob.

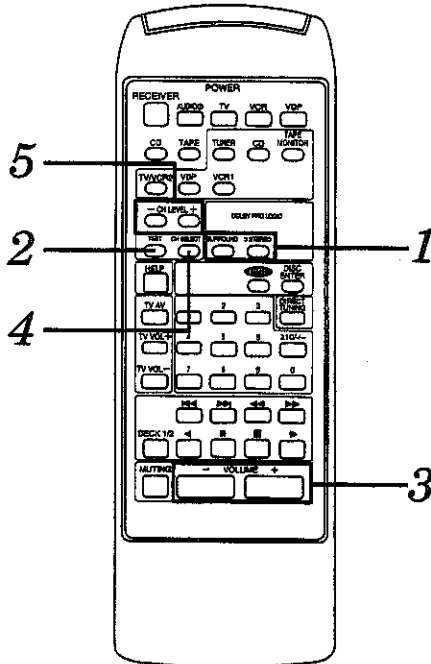

**1** Press **SURROUND** or **3 STEREO** to turn on the Dolby Pro Logic systems and select the desired mode.

For **SURROUND** mode

**SURROUND** DOLBY SURROUND PRO LOGIC

Displayed for approximately 1 second only.

For **3 STEREO** mode

**3 STEREO** 3 STEREO

Displayed for approximately 1 second only.

**2** Press **TEST** to output a test signal.

**TEST L**

The speaker outputting the test signal is displayed while the test is running.

- L : Front speaker (left)
- C : Center speaker
- R : Front speaker (right)
- S : Surround speakers

For **surround mode**  
L → C → R → S

In the **PHANTOM** mode, the center speaker is OFF, so the test signal is not output and "C" is not displayed.

For **3 STEREO mode**  
L → C → R

**3** Press **VOLUME (-) or (+)** to set the volume level normally used for enjoying the source.

The following steps are for setting the output level of the front speakers and the center/surround speakers to the same listening level.

**4** Press **CH SELECT** to select the speaker you want to adjust.

For the center speaker

**C 0dB**

For the surround speakers

**S 0dB**

## Enjoying with SURROUND or 3 STEREO

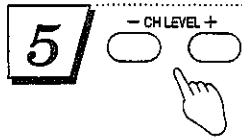
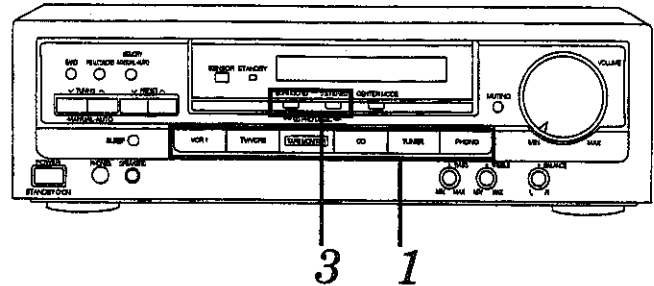

**5** Press CH LEVEL (-) or (+) to adjust the output level.

- : Decrease the output level.
- + : Increase the output level.

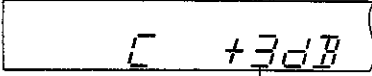

Output level can be varied within a range of -12 dB to +12 dB with front speaker output level serving as the zero point.

**6**

Repeat steps 4 and 5 until the output level of all speakers is the same.

**Note**

1. The test signal is output only by the speaker you are now adjusting and does not repeat the sequence until adjustments are complete.
2. Remember you cannot adjust output level of the surround speakers if you selected the 3 stereo mode in step 1.

**To stop the test signal**



Press TEST.

**To turn off the Dolby Pro Logic systems**



Press the button of the currently selected mode (SURROUND or 3 STEREO).

or



**1**



Select the desired source.

**2**

Start the desired source.

**Note**

When employing SURROUND, use software recorded in Dolby Surround.

**3**



Press SURROUND or 3 STEREO to turn on the desired mode.

or



Pressing the same button again turns off the activated listening mode.

# Making a recording

## Recording on the tape deck

Before recording, prepare the tape deck for recording (recording level adjustment, etc.).

See the tape deck's operating instructions for details.

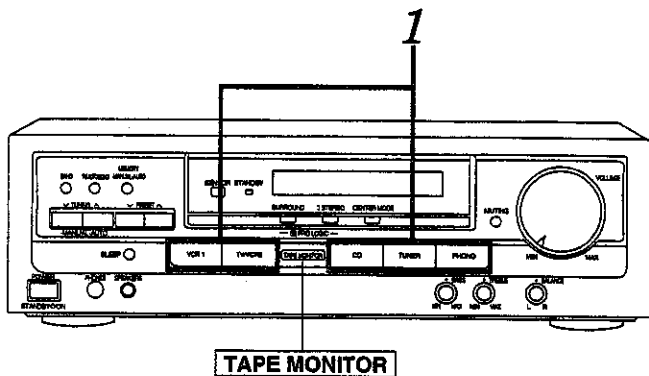

- 1** Select the desired source to be recorded.

Press any button except TAPE MONITOR to select the source you want to record from.

- 2** Begin recording.

Follow your tape deck's operating instructions.

- 3** Begin the desired source to be recorded.

### To check the sound recorded while a recording is being made

With a tape deck with 3 head system, it is possible to check the sound recorded on the tape.

Press **TAPE MONITOR** on this unit and set the monitor button on the tape deck to "TAPE".

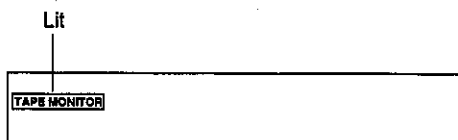

Press **TAPE MONITOR** once again to turn it off.

## Recording on the VCR (VCR 1)

Before recording, prepare the VCR (VCR1) for recording (recording level adjustment, input selector setting, etc.).

See the VCR's operating instructions for details.

## Recording from an audio source

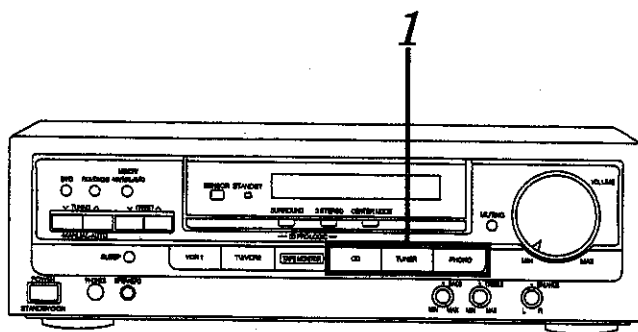

- 1** Select the audio source to be recorded.

Press either CD, TUNER or PHONO to select the source you want to record from.

#### Note

Recording from the tape deck is not possible.

- 2** Begin recording on the VCR

  - Follow your VCR's operating instructions.

- 3** Begin the audio source to be recorded.

## Recording from the TV **SA-EX300 only**

If a TV is connected to the "TV/VCR 2" terminals, you can record off it.

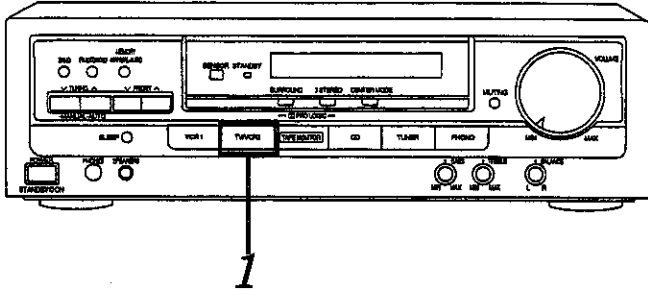

## Recording from a second VCR (VCR 2) **SA-EX300 only**

If a second VCR is connected to the "TV/VCR 2" terminals, you can record off it.

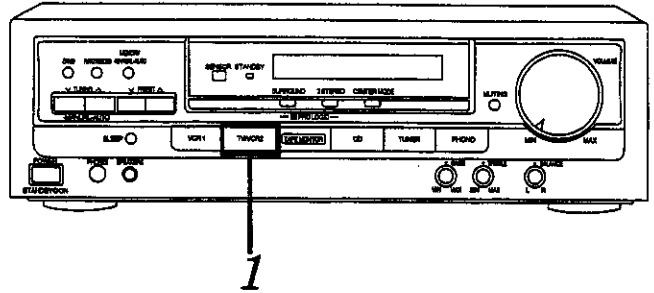

### Note

Be sure to set the TV/VIDEO mode on the TV to "TV".

To watch the picture you are recording into VCR 1, set the TV to the VIDEO mode.

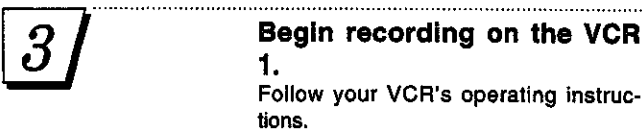
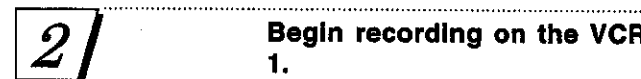
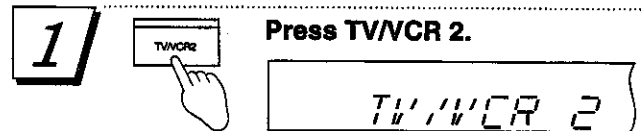
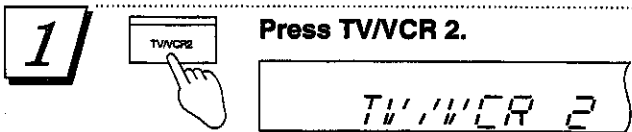

# Sleep timer function

The sleep timer is an excellent little feature that lets you fall asleep with the radio. You can set the timer to turn off after 30, 60 or 90 minutes.

**Note**

The sleep timer turns off the receiver, but it does not turn off any externally connected components.

SA-EX300

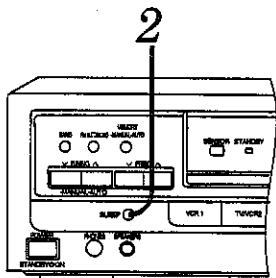

SA-EX100

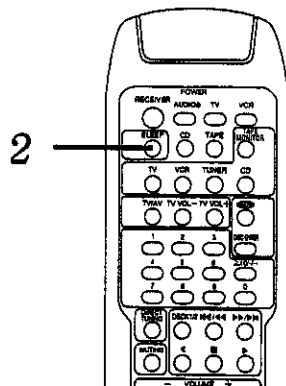

# About the HELP function

SA-EX300 only

If you make a mistake in operation or if sound output stops due to some operation which was performed, the HELP function displays information which can be useful for indicating the method by which this condition can be remedied.

If "ERROR" or scrolling characters (for instance, "TAPE MONITOR ON NOW") appears on the display during operation, carry out the following operation.

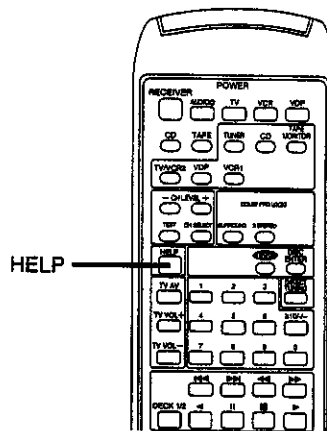

**1** Set to the desired broadcast.  
(See pages 14-16.)

**2** **SA-EX300** (While listening a source)  
Press **SLEEP** and set how long (minutes) you want the source to continue playing.



SA-EX100



30 → 60 → 90 → OFF

The display returns to the way it was before in about 5 seconds, and the "SLEEP" indicator will appear on the displayed.

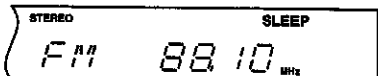

Press **HELP** on the remote control transmitter.

The method for remedying this situation will be displayed.

### To cancel the sleep timer

Press **SLEEP** until "OFF" is displayed. The "SLEEP" indicator will go out.

### To check how much time is left (while the timer is running)

Press **SLEEP** once.

**Note**

Do not press **SLEEP** again before the remaining time indication goes out. If you do so, the timer will return to the setting mode.

### To change the setting time (while the timer is running)

1. Press **SLEEP**.
2. Press **SLEEP** again while the remaining time is displayed and then reset the timer (30, 60 or 90 minutes).

# Troubleshooting guide

Before requesting service for this unit, check the chart below for a possible cause of the problem you are experiencing. Some simple checks or a minor adjustment on your part may eliminate the problem and restore proper operation.

If you are in doubt about some of the check points, or if the remedies indicated in the chart do not solve the problem, refer to

the directory of Authorized Service Centers (enclosed with this unit) to locate a convenient service center, or consult your Technics dealer for instructions.

Problem	Probable cause(s)	Suggested remedy
---------	-------------------	------------------

While listening to FM broadcasts		
An unusual hissing noise is heard when listening to the broadcast in stereo, but not heard when listening monaurally.	A slight noise may be heard because the method used for modulation of FM stereo broadcasts is different than that used for monaural broadcasts.	<ul style="list-style-type: none"> <li>• Try reducing the treble sound by using the treble control.</li> <li>• Try changing the location, height and/or direction of the antenna.</li> <li>• If an indoor antenna is being used, change to an outdoor antenna.</li> <li>• Try using an antenna with more elements.</li> </ul>
Noise is excessive in both stereo and monaural broadcasts.	Poor location and/or direction of the antenna.	<ul style="list-style-type: none"> <li>• Try using an antenna with more elements.</li> </ul>
	Transmitting station is too far away.	
The FM stereo indicator or the quartz lock indicator flickers, without completely illuminating.	Poor location and/or direction of the antenna.	<ul style="list-style-type: none"> <li>• Try changing the location, height and/or direction of the antenna.</li> <li>• If an indoor antenna is being used, change to an outdoor antenna.</li> <li>• Try using an antenna with more elements.</li> </ul>
	Transmitting station is too far away.	
Excessive distortion in the sound of stereo broadcasts.	Nearby building or mountain.	<ul style="list-style-type: none"> <li>• Try using an antenna with more elements.</li> </ul>

While listening to AM broadcasts		
An unusual "beat" sound is heard.	Unit is being used at the same time as the television set.	<ul style="list-style-type: none"> <li>• Turn off the television set, or use this unit farther away from it.</li> </ul>
	Interference from adjacent broadcast signals.	<ul style="list-style-type: none"> <li>• Try reducing the treble sound by using the treble control.</li> </ul>
A low-pitched "hum" sound is heard when the broadcast is tuned.	The AM loop antenna connection wires are too close to the power cord.	<ul style="list-style-type: none"> <li>• Place the antenna connection wires and the power cord farther apart.</li> </ul>
	The power supply frequency from the power cord is modulated and heard from the speakers.	<ul style="list-style-type: none"> <li>• Install a special outdoor antenna.</li> </ul>
A strange hissing noise is produced continuously or intermittently.	Caused by the "discharge phenomenon" and the "oscillation phenomenon" of electric appliances (such as fluorescent lights, TV, small series-type motors, rectification equipment, etc.).	<ul style="list-style-type: none"> <li>• Try placing this unit farther away from such equipment.</li> </ul>

Problems noted at all times		
No sound is heard.	Connections are incomplete or incorrect to the speaker systems, etc.	<ul style="list-style-type: none"> <li>• Check to be sure that all connection wires are correctly connected.</li> </ul>
	The incorrect input selector has been pressed.	<ul style="list-style-type: none"> <li>• Check to be sure that the correct selector is pressed.</li> </ul>
	The tape monitor function is ON.	<ul style="list-style-type: none"> <li>• Press the tape monitor button.</li> </ul>
	The muting function is ON.	<ul style="list-style-type: none"> <li>• Press the muting button.</li> </ul>
	The speaker indicator is turned off.	<ul style="list-style-type: none"> <li>• Turn on the speaker indicator.</li> </ul>
Sound stops during a performance, or no sound is heard when the power is switched ON. (The word "OVERLOAD" appears on the display.)	The protection circuitry has functioned because the positive and negative speaker connection wires are "shorted", speaker systems with an impedance less than the indicated rated impedance of this unit are used or under severe use, such as loud volume, excessive power and in an excessively hot environment.	<ul style="list-style-type: none"> <li>• Switch off the power, and after determining and correcting the cause, switch on the power once again.</li> <li>• Use a speaker system of the proper impedance rating.</li> </ul>

# Technical specifications (DIN 45 500)

## ■ AMPLIFIER SECTION

Power output (at 240 V)	
DIN 1 kHz (T.H.D. 1%)	[SA-EX300] 2×50 W (8 Ω) [SA-EX100] 2×100 W (8 Ω)
40 Hz–20 kHz continuous power output both channels driven	[SA-EX300] 2×30 W (8 Ω) [SA-EX100] 2×80 W (8 Ω)
Total harmonic distortion	
rated power at 40 Hz–20 kHz	0.5% (8 Ω)
half power at 1 kHz	0.03% (8 Ω)
Power output at the Dolby Pro Logic operation [SA-EX300 only]	
DIN 1 kHz (T.H.D. 1%)	
Front	2×40 W (8 Ω)
Center	40 W (8 Ω)
Surround	40 W (8 Ω)
Load impedance	
Front	8–16 Ω
Center [SA-EX300 only]	8–16 Ω
Surround [SA-EX300 only]	4–16 Ω
Intermodulation distortion	
rated power at 60 Hz: 7 kHz 4:1, SMPTE	0.5% (8 Ω)
Power bandwidth	
both channels driven, –3 dB	10 Hz–40 kHz (8 Ω)
Damping factor	30 (8 Ω)
Frequency response	
PHONO	RIAA standard curve (30 Hz–15kHz) ±0.8 dB
[SA-EX300] CD, VCR 1, TV/VCR 2, TAPE	10 Hz–40 kHz, ±3 dB
[SA-EX100] CD, VCR, TAPE	10 Hz–40 kHz, ±3 dB
input sensitivity and impedance	
PHONO	3 mV/47 kΩ
[SA-EX300] CD, VCR 1, TV/VCR 2, TAPE	200 mV/22 kΩ
[SA-EX100] CD, VCR, TAPE	200 mV/22 kΩ
S/N at rated power (8 Ω)	
PHONO	70 dB (IHF, A: 80 dB)
[SA-EX300] CD, VCR 1, TV/VCR 2, TAPE	75 dB (IHF, A: 88 dB)
[SA-EX100] CD, VCR, TAPE	75 dB (IHF, A: 88 dB)
Tone controls	
BASS	50 Hz, +10 to –10 dB
TREBLE	20 kHz, +10 to –10 dB
Output voltage	
[SA-EX300] VCR 1 OUT, TAPE REC (OUT)	200 mV
[SA-EX100] VCR OUT, TAPE REC (OUT)	200 mV
Channel balance (250 Hz–6.3 kHz)	±1 dB
Channel separation	55 dB
Headphones output level and impedance	430 mV/330 Ω

## ■ FM TUNER SECTION

Frequency range	87.50–108.00 MHz
Sensitivity	
S/N 30 dB	1.5 μV/75 Ω
S/N 26 dB	1.3 μV/75 Ω
S/N 20 dB	1.2 μV/75 Ω
IHF usable sensitivity	1.5 μV/75 Ω (IHF '58)
IHF 46 dB stereo quieting sensitivity	22 μV/75 Ω
Total harmonic distortion	
MONO	0.2%
STEREO	0.3%

## S/N

MONO	60 dB (75 dB, IHF)
STEREO	58 dB (71 dB, IHF)
Frequency response	20 Hz–15 kHz, +1 dB, –2 dB
Alternate channel selectivity	
±400 kHz	65 dB
Capture ratio	1 dB
Image rejection at 98 MHz	40 dB
IF rejection at 98 MHz	70 dB
Spurious response rejection at 98 MHz	70 dB
AM suppression	50 dB
Stereo separation	
1 kHz	40 dB
Carrier leak	
19 kHz	–30 dB (–35 dB, IHF)
38 kHz	–50 dB (–55 dB, IHF)
Channel balance (250 Hz–6.3 kHz)	±1.5 dB
Limiting point	1.2 μV
Bandwidth	
IF amplifier	180 kHz
FM demodulator	1000 kHz
Antenna terminal(s)	75 Ω (unbalanced)

## ■ AM TUNER SECTION

Frequency range	
AM	522–1611 kHz (9 kHz steps) 530–1620 kHz (10 kHz steps)
Sensitivity	
AM	20 μV, 330 μV/m
Selectivity	
AM (at 999 kHz)	55 dB
Image rejection	
AM (at 999 kHz)	40 dB
IF rejection	
AM (at 999 kHz)	55 dB

## ■ VIDEO SECTION [SA-EX300 only]

Output voltage at 1 V input (unbalanced)	1±0.1 Vp-p
Maximum input voltage	1.5 Vp-p
Input/output impedance	75 Ω (unbalanced)

## ■ GENERAL

Power consumption	[SA-EX300] 200 W [SA-EX100] 160 W
Power supply	AC 50 Hz/60 Hz, 230–240 V
Dimensions (W×H×D)	[SA-EX300] 430×136×358 mm [SA-EX100] 430×136×309 mm
Weight	[SA-EX300] 8.7 kg [SA-EX100] 6.2 kg

## Notes:

- Specifications are subject to change without notice. Weight and dimensions are approximate.
- Total harmonic distortion is measured by the digital spectrum analyzer.

Matsushita Electric Industrial Co., Ltd.  
Central P.O. Box 288, Osaka 530-91, Japan



# Technics®

## How to use the remote control transmitter EUR642175



This remote control transmitter can be used to operate other units manufactured by this company in addition to this receiver, including TVs and VCRs manufactured since 1985, CD players (or CD changers) and cassette decks which are equipped with a remote control sensor.

For detailed information concerning operation steps, etc., please refer to the appropriate page for each unit and the respective operating instructions.

## Before use

### Battery installation

Insert the batteries included with this unit as shown below.

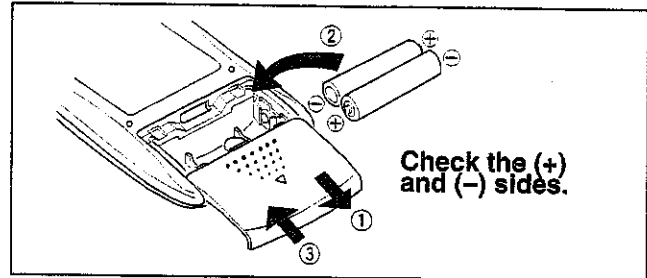

### Use of batteries

- Do not mix old and new batteries, or batteries of different types (carbon, alkaline, etc.).
- Never subject batteries to excessive heat or flame; do not attempt to disassemble them; and be sure they are not short-circuited.
- If the remote control is not to be used for a long period of time, remove the batteries and store them in a cool, dark place.
- Do not attempt to recharge alkaline or carbon batteries.
- Do not use rechargeable type batteries.

### Battery life

Battery life is about one year.

The batteries should be replaced if the receiver fails to respond to commands from the remote control transmitter even when held close to the remote control signal sensor.

### When you need to replace these batteries

Use two UM-4, "AAA", IEC R03 (1.5 V) or equivalent batteries.

### Correct method of use

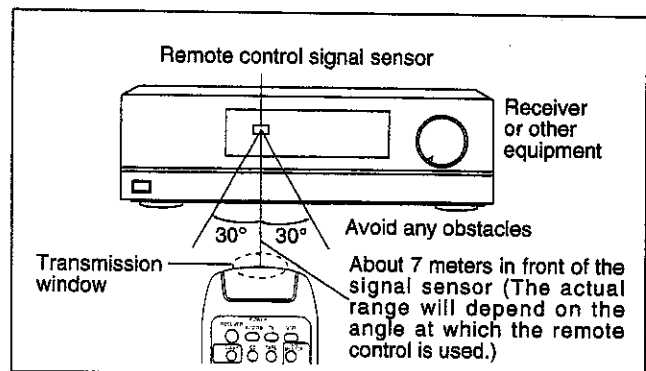

### Operation notes

- Aim the remote control's transmission window toward the unit's sensor. Avoid any obstacles.
- Be sure the transmission window and the unit's sensor are free from dust. Excessive dust might affect performance.
- Do not expose the remote control signal sensor to direct sunlight or to the bright light of an inverter fluorescent light.

# Remote control operation

To turn the receiver ON/OFF

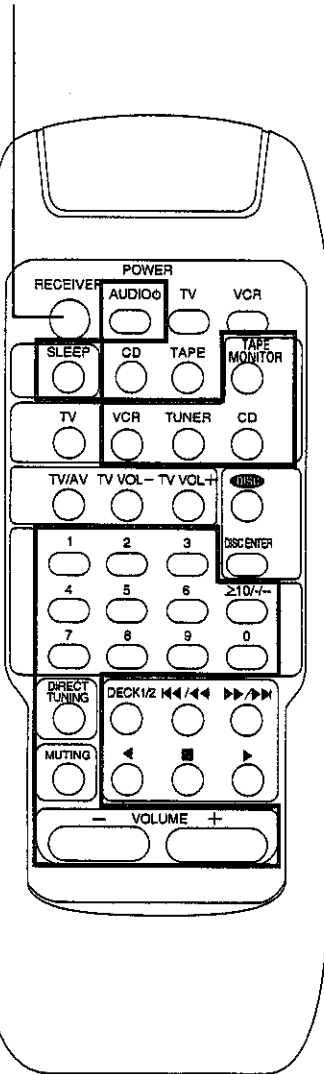

## To operate the receiver

To select an input source

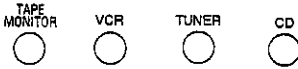

To mute the sound level

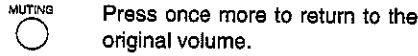

To adjust the volume level



To turn the audio system OFF

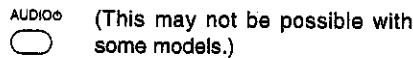

To listen to radio broadcasts



To switch the remote control transmitter to tuner operation mode

Be sure to press this button before operating the receiver.

To select the desired channel  
(Preset tuning)

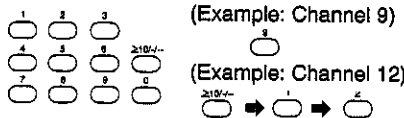

To select radio stations by frequency  
(Direct tuning)

First select the band with the BAND button on the receiver.

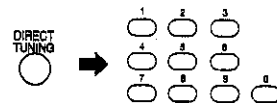

(Example: 107.90MHz)

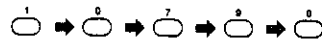

To select the sleep timer

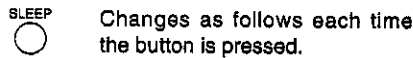

30—60—90—OFF

To turn the CD player (or CD changer) ON/OFF

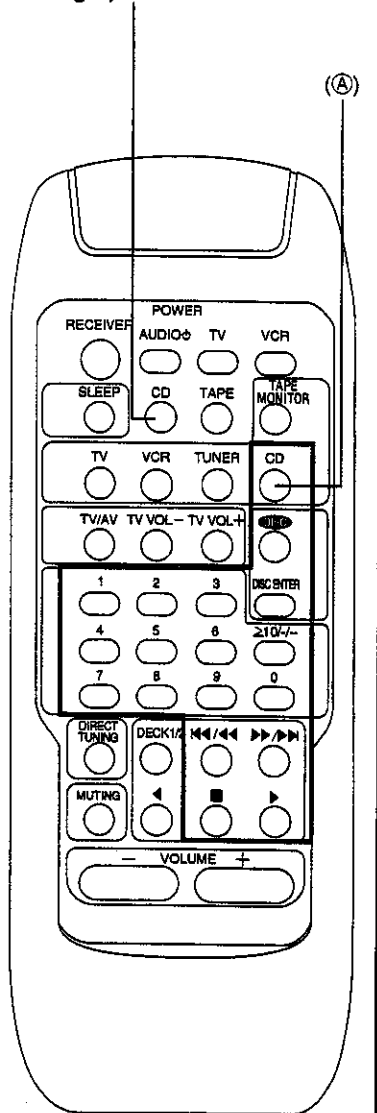

# Remote control operation

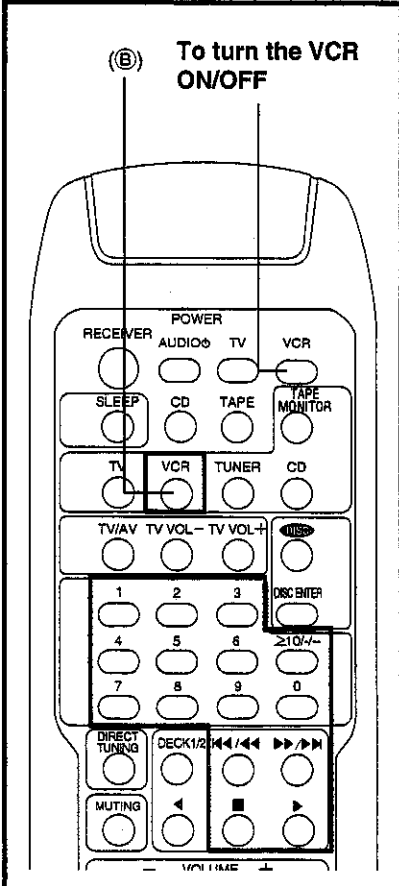
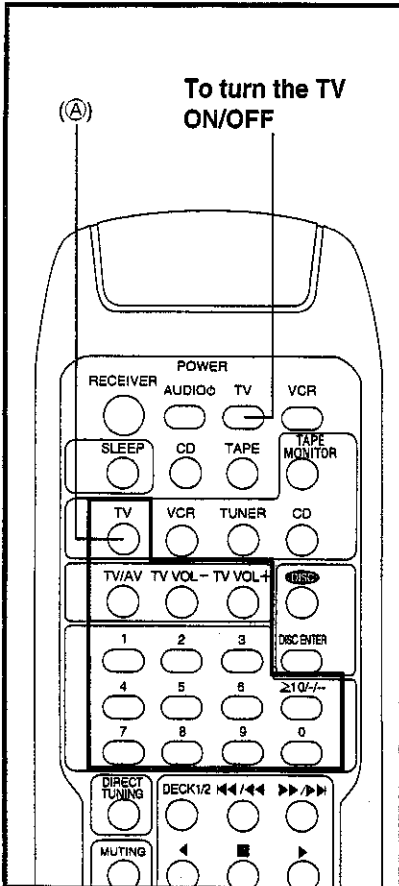

## To operate a TV

To switch the remote control to TV operation mode

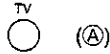

Be sure to press this button before operating the TV.

To select the TV/VIDEO mode



To select the desired channel

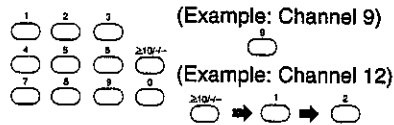

To adjust the volume level



## To operate a VCR

To switch the remote control to VCR operation mode

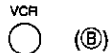

Be sure to press this button before operating the VCR.

To start play



To select the desired channel

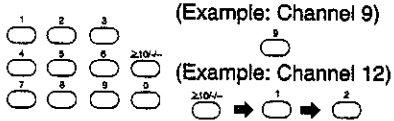

To fast-forward or rewind the tape

In the stop mode



To stop play



## To operate a CD player (or CD changer)

To switch the remote control to CD player (or CD changer) operation mode

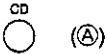

Be sure to press this button before operating the CD player (or CD changer).

To start play



[CD changer only]

To start play from the desired disc  
(For 5 CD changer)

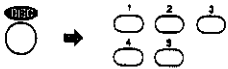

(For MEGA CD changer ※)

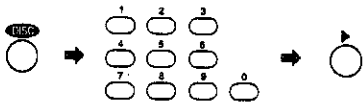

If you select "0", the changer will switch to the single disc play mode.  
(When selecting discs, the ≥10/-- button does not respond to touch.)



**For your reference**

If you press this button instead of the ► button shown in the above procedure, the CD changer will stop and display the disc number.  
To start the disc, press ►.

To start play from the desired track

(Example: track 9)

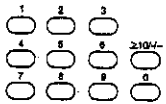

(Example: track 12)

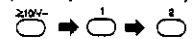

To skip a track

(Backward) (Forward)

To stop play



To turn the cassette deck ON/OFF

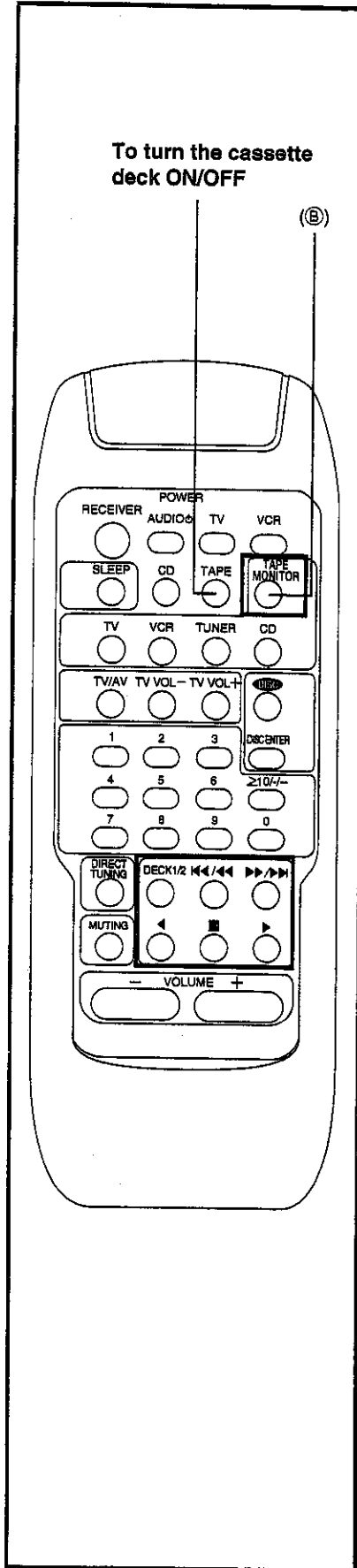

## To operate a cassette deck

To switch the remote control to cassette deck operation mode



Be sure to press this button before operating the cassette deck.

(Only when using a double cassette deck)

To select the tape deck  
(DECK 1/DECK 2)



The remote control indicator of the cassette deck will change each time the button is pressed.

To start playback

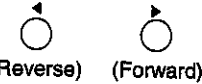

To fast-forward or rewind the tape

In the stop mode



With TPS-equipped cassette decks, while the tape is playing, you can move to the beginning of a track by pressing these buttons.

To stop playback



※ By "MEGA CD changer", it is meant any Technics CD changer that takes more than 50 discs.